

Pre-Processing & Correction of Digital Image

Unit: I

Semester: I

Paper Code: GIS 04

Name of Paper: Digital Image Processing

PG Diploma in RS & GIS

Dr. SHYAMA PRASAD MUKHERJEE UNIVERSITY, RANCHI

Pre-Processing & Correction of Digital Image

9.1 Radiometric Correction

As any image involves radiometric errors as well as geometric errors, these errors should be corrected. **Radiometric correction** is to avoid radiometric errors or distortions, while geometric correction is to remove geometric distortion.

When the emitted or reflected electro-magnetic energy is observed by a sensor on board an aircraft or spacecraft, the observed energy does not coincide with the energy emitted or reflected from the same object observed from a short distance. This is due to the sun's azimuth and elevation, atmospheric conditions such as fog or aerosols, sensor's response etc. which influence the observed energy. Therefore, in order to obtain the real irradiance or reflectance, those radiometric distortions must be corrected.

Radiometric correction is classified into the following three types (see [Figure 9.1.1](#).)

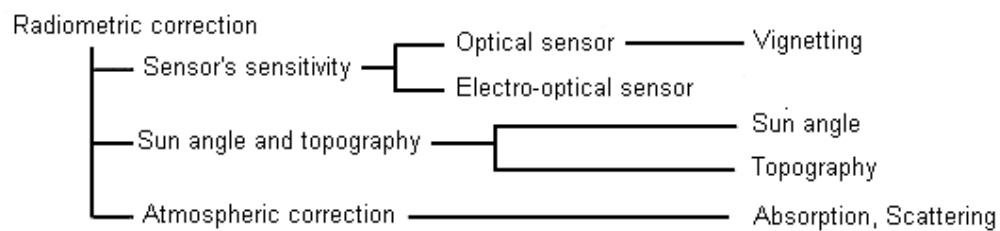

Figure 9.1.1 Radiometric correction

(1) Radiometric correction of effects due to sensor sensitivity

In the case of optical sensors, with the use of a lens, a fringe area in the corners will be darker as compared with the central area. This is called **vignetting**. Vignetting can be expressed by $\cos^4 \theta$, where θ is the angle of a ray with respect to the optical axis. n is dependent on the lens characteristics, though n is usually taken as 4. In the case of electro-optical sensors, measured calibration data between irradiance and the sensor output signal, can be used for radiometric correction.

(2) Radiometric correction for sun angle and topography: -

a. Sun spot

The solar radiation will be reflected diffusely onto the ground surface, which results in lighter areas in an image. It is called a **sun spot**. The sun spot together with vignetting effects can be corrected by estimating a shading curve which is determined by Fourier analysis to extract a low frequency component (see [Figure 9.1.2](#)).

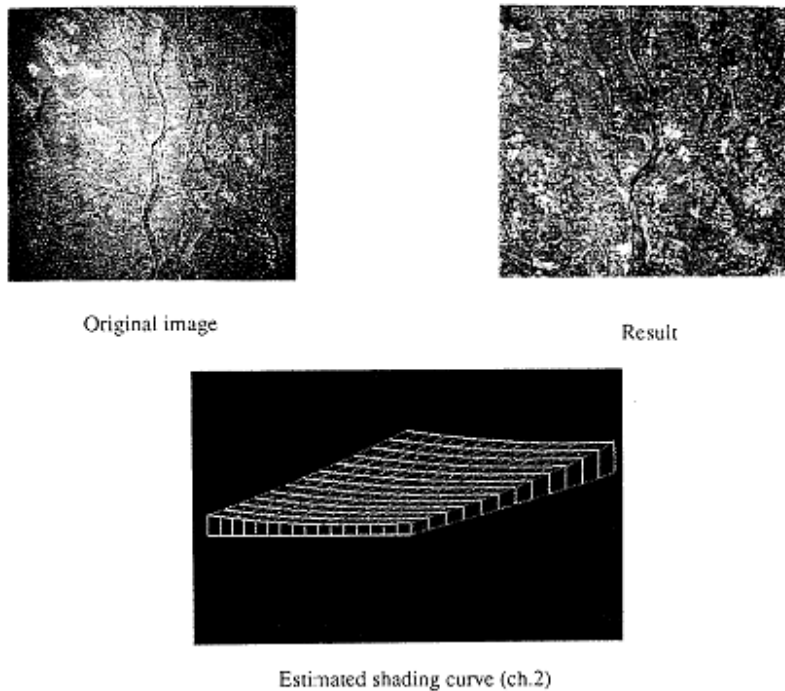

Figure 9.1.2 Correction by estimating a shading curve

b. Shading

The shading effect due to topographic relief can be corrected using the angle between the solar radiation direction and the normal vector to the ground surface.

(3) Atmospheric correction

Various atmospheric effects cause absorption and scattering of the solar radiation. Reflected or emitted radiation from an object and **path radiance** (atmospheric scattering) should be corrected for. (see [9.2](#)).

9.2 Atmospheric Correction

The solar radiation is absorbed or scattered by the atmosphere during transmission to the ground surface, while the reflected or emitted radiation from the target is also absorbed or scattered by the atmosphere before it reaches a sensor. The ground surface receive not only the direct solar radiation but also **sky light**, or scattered radiation from the atmosphere. A sensor will receive not only the direct reflected or emitted radiation from a target, but also the scattered radiation from a target and the scattered radiation from the atmosphere, which is called **path radiance**. **Atmospheric correction** is used to remove these effects (see [Figure 9.2.1](#) and [Figure 9.2.2](#)).

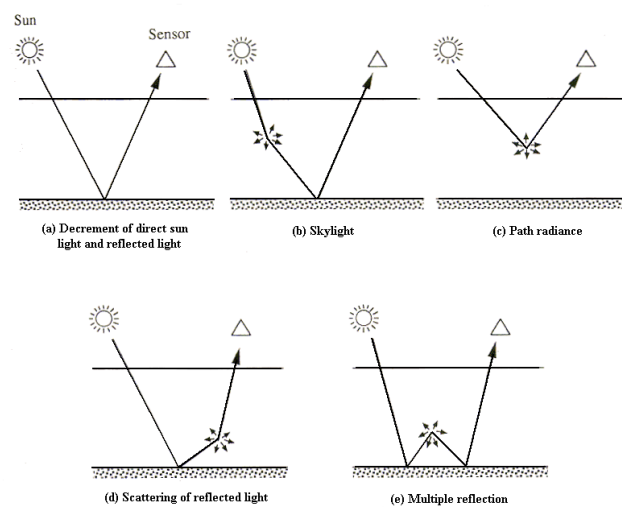

Figure 9.2.1 Atmospheric effect

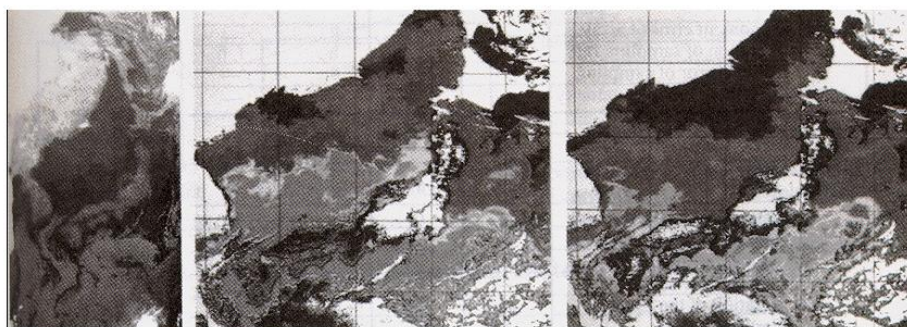

Figure 9.2.2 Atmospheric correction

The atmospheric correction method is classified into the method using the radiative transfer equation, the method using ground truth data and other methods.

a. **The method using the radiative transfer equation**

An approximate solution is usually determined for the **radiative transfer equation**. For atmospheric correction, **aerosol** density in the visible and near infrared region and **water vapor** density in the thermal infrared region should be estimated. Because these values cannot be determined from image data, a rigorous solution cannot be used.

b. **The method with ground truth data**

At the time of data acquisition, those targets with known or measured reflectance will be identified in the image. Atmospheric correction can be made by comparison between the known value of the target and the image data (output signal). However, the method can only be applied to the specific site with targets or a specific season.

c. **Other method**

A special sensor to measure aerosol density or water vapor density is utilized together with an imaging sensor for atmospheric correction. For example, the NOAA satellite has not only an imaging sensor of AVHRR (Advanced Very High-Resolution Radiometer) but also HIRS (High Resolution Infrared Radiometer Sounder) for atmospheric correction.

9.3 Geometric Distortions of the Image

Geometric distortion is an error on an image, between the actual image coordinates and the ideal image coordinates which would be projected theoretically with an ideal sensor and under ideal conditions.

Geometric distortions are classified into **internal distortion** resulting from the geometry of the sensor, and **external distortions** resulting from the attitude of the sensor or the shape of the object.

[Figure 9.3.1](#) schematically shows examples of internal distortions, while [Figure 9.3.2](#) shows examples of external distortions.

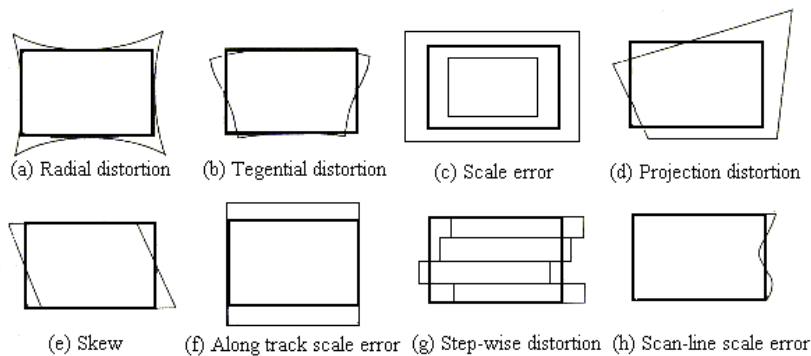

Figure 9.3.1 Internal Distortions

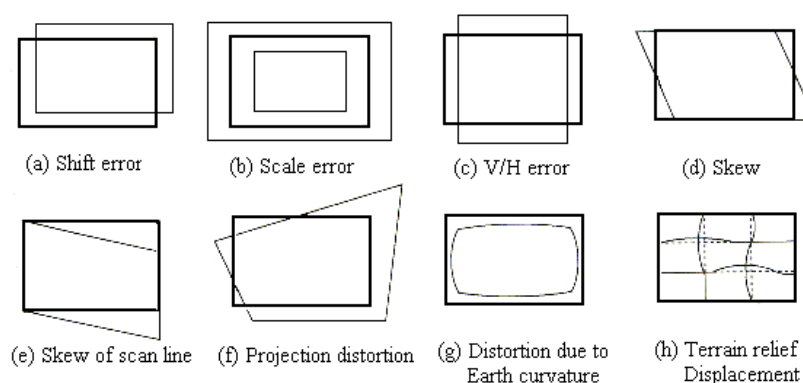

Figure 9.3.2 External Distortions

[Table 9.3.1](#) shows the causes of internal and external distortions and the types of distortions

9.4 Geometric Correction

Geometric correction is undertaken to avoid geometric distortions from a distorted image, and is achieved by establishing the relationship between the image coordinate system and the geographic coordinate system using calibration data of the sensor, measured data of position and attitude, ground control points, atmospheric condition etc.

The steps to follow for geometric correction are as follows (see [Figure 9.4.1](#))

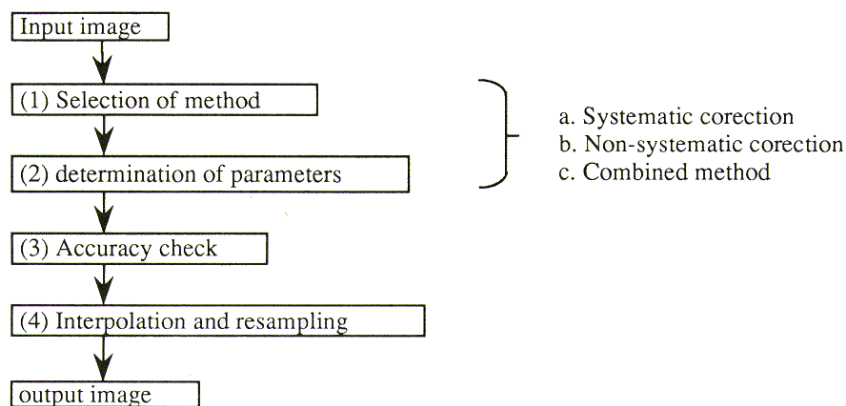

Figure 9.4.1 The flow of geometric correction

(1) Selection of method

After consideration of the characteristics of the geometric distortion as well as the available reference data, a proper method should be selected.

(2) Determination of parameters

Unknown parameters which define the mathematical equation between the image coordinate system and the geographic coordinate system should be determined with calibration data and/or ground control points.

(3) Accuracy check

Accuracy of the geometric correction should be checked and verified. If the accuracy does not meet the criteria, the method or the data used should be checked and corrected in order to avoid the errors.

(4) Interpolation and resampling

Geo-coded image should be produced by the technique of resampling and interpolation.

There are three methods of geometric correction as mentioned below.

a. Systematic correction

When the geometric reference data or the geometry of sensor are given or measured, the geometric distortion can be theoretically or systematically avoided. For example, the geometry of a lens camera is given by the collinearity equation with calibrated focal length, parameters of lens distortions, coordinates of fiducial marks etc. The tangent correction for an optical mechanical scanner is a type of system correction. Generally systematic correction is sufficient to remove all errors.

b. Non-systematic correction

Polynomials to transform from a geographic coordinate system to an image coordinate system, or vice versa, will be determined with given coordinates of ground control points using the least square method. The accuracy depends on the order of the polynomials, and the number and distribution of ground control points(see [Figure 9.4.2](#)).

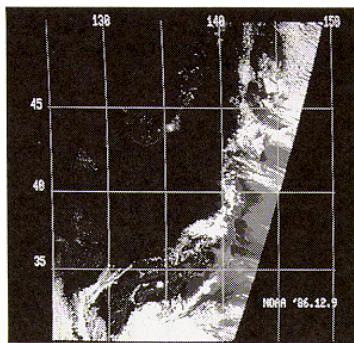

Figure 9.4.2 Geometric correction for NOAA AVHRR (Non-systematic correction ; Polynomials)

c. Combined method

Firstly the systematic correction is applied, then the residual errors will be reduced using lower order polynomials. Usually the goal of geometric correction is to obtain an error within plus or minus one pixel of its true position(see [Figure 9.4.3](#))

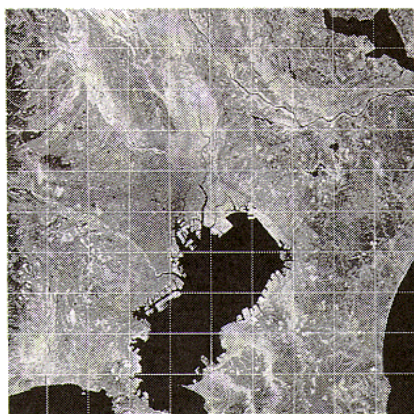

Figure 9.4.3 Geometric correction for LANDSAT MSS (Combined method)

9.5 Coordinate Transformation

The technique of coordinate transformation is useful for geometric correction with ground control points (GCP). The key points are contained in the following two selections.

a. Selection of transform formula

Depending on the geometric distortions, the order of polynomials will be determined. Usually a maximum of a third order polynomials will be sufficient for existing remote sensing images, such as LANDSAT. [Table 9.5.1](#) shows the examples of available formulas.

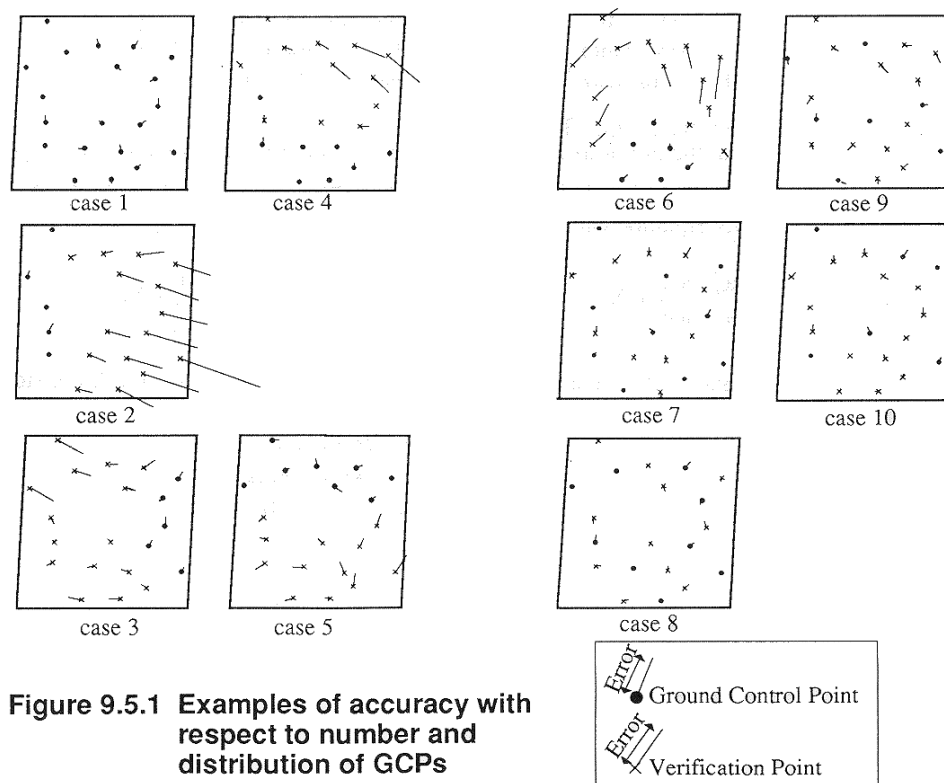

b. Selection of ground control points

The number and distribution of ground control points will influence the accuracy of the geometric correction. The number of GCP's should be more than the number of unknown parameters as shown in Table 1, because the errors will be adjusted by the least square method.

The distribution of GCP's should be random, but almost equally spaced including corner areas. About ten to twenty points which are clearly identified both on the image and the map should

be selected depending on the order of the selected formula or the number of unknown parameters. [Figure 9.5.1](#) shows the comparison of accuracy with respect to number and distribution of GCP's. The accuracy of geometric correction is usually represented by the standard deviation (RMS), in pixel units, in the image plane as follows.

σ_u : standard deviation in pixel number

σ_v : standard deviation in line number

where

$$\sigma_u^2 = \Sigma \{u_i - f(x_i, y_i)\}^2 / n$$

$$\sigma_v^2 = \Sigma \{v_i - g(x_i, y_i)\}^2 / n$$

(u_i, v_i) : image coordinates of the i th ground control point

(x_i, y_i) : map coordinates of the i th ground control point

$f(x_i, y_i)$: coordinate transformation from map coordinates to pixel number

$g(x_i, y_i)$: coordinate transformation from map coordinate to line number

The accuracy should be usually within +/- one pixel. If the error is larger than the requirement, the coordinates on the image or map should be rechecked, otherwise the formula should be reselected.

9.6 Collinearity Equation

The **Collinearity equation** is a physical model representing the geometry between a sensor (projection center), the ground coordinates of an object and the image coordinates, while the coordinate transformation technique as mentioned in 9.5 can be considered as a black box type of correction. The collinearity equation gives the geometry of a bundle of rays connecting the projection center of a sensor, an image point and an object on the ground, as shown in [Figure 9.6.1](#).

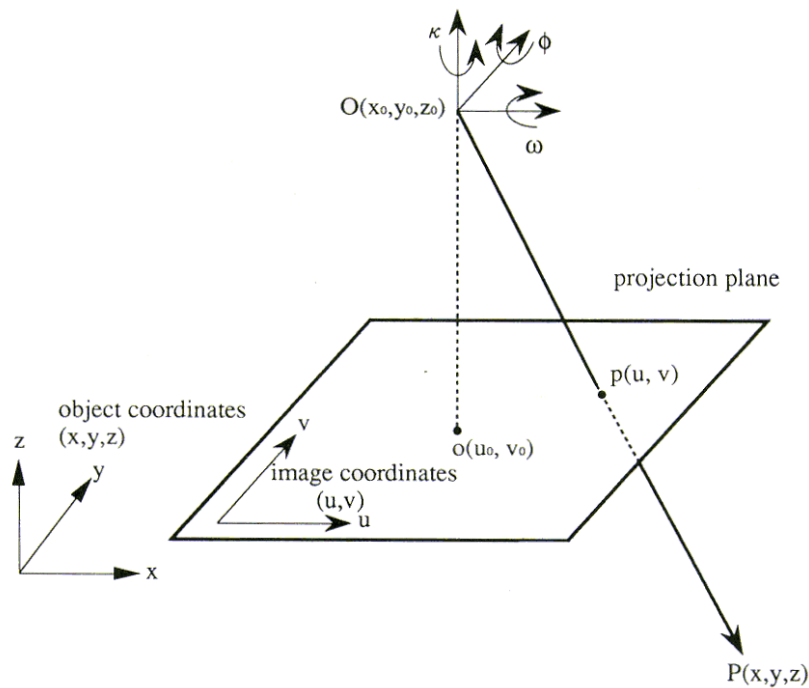

Figure 9.6.1 Geometry of Central Projection Sensor

For convenience, an optical camera system is described to illustrate the principle. Let the projection center or lens be $O(X_0, Y_0, Z_0)$, with rotation angles ω , ϕ , κ around X , Y and Z axis respectively (roll, pitch and yaw angles), the image coordinates be $p(x, y)$ and the ground coordinates be $P(X, Y, Z)$. The collinearity equation is given as follows-

$$x = -f \frac{a_1(X-X_0) + a_2(Y-Y_0) + a_3(Z-Z_0)}{a_7(X-X_0) + a_8(Y-Y_0) + a_9(Z-Z_0)}$$

$$y = -f \frac{a_4(X-X_0) + a_5(Y-Y_0) + a_6(Z-Z_0)}{a_7(X-X_0) + a_8(Y-Y_0) + a_9(Z-Z_0)}$$

where f : focal length of lens, and a_1 to a_9 are given by the following matrix relationship.

$$\begin{pmatrix} a_1 a_2 a_3 \\ a_4 a_5 a_6 \\ a_7 a_8 a_9 \end{pmatrix} = \begin{pmatrix} 1 & 0 & 0 \\ 0 & \cos\omega & \sin\omega \\ 0 & -\sin\omega & \cos\omega \end{pmatrix} \begin{pmatrix} \cos\psi & 0 & -\sin\psi \\ 0 & 1 & 0 \\ \sin\psi & 0 & \cos\psi \end{pmatrix} \begin{pmatrix} \cos\kappa & -\sin\kappa & 0 \\ \sin\kappa & \cos\kappa & 0 \\ 0 & 0 & 1 \end{pmatrix}$$

In the case of a camera, the previous formula includes six unknown parameters (X_0, Y_0, Z_0 ; ω , ψ , κ) which can be determined with the use of more than three ground control points (X_i, Y_i, Z_i). The collinearity equation can be inverted as follows-

$$X = (Z - Z_0) \frac{a_1 X + a_4 Y - a_7 f}{a_3 X + a_6 Y - a_9 f} + X_0$$

$$Y = (Z - Z_0) \frac{a_2 X + a_5 Y - a_8 f}{a_3 X + a_6 Y - a_9 f} + Y_0$$

In the case of a flat plane (Z : constant), the formula coincides with the two dimensional projection as listed in [Table 9.5.1](#). The geometry of an optical mechanical scanner and a CCD linear array sensor is a little different from the one of a frame camera. Only the cross-track direction is a central projection similar to a frame camera, while along track direction is almost parallel ($y=0$) with a slight variation of orbit and attitude, as a function of time or line number, of not more than a third order as follows.

$$X_0 = X_0(l) = X_0 + X_1 l + X_2 l^2 + X_3 l^3$$

$$Y_0 = Y_0(l) = Y_0 + Y_1 l + Y_2 l^2 + Y_3 l^3$$

$$Z_0 = Z_0(l) = Z_0 + Z_1 l + Z_2 l^2 + Z_3 l^3$$

$$\omega_0 = \omega_0(l) = \omega_0 + \omega_1 l + \omega_2 l^2 + \omega_3 l^3$$

$$\psi_0 = \psi_0(l) = \psi_0 + \psi_1 l + \psi_2 l^2 + \psi_3 l^3$$

$$\kappa_0 = \kappa_0(l) = \kappa_0 + \kappa_1 l + \kappa_2 l^2 + \kappa_3 l^3$$

, where l is line number

9.7 Resampling and Interpolation

In the final stage of geometric correction, a geo-coded image will be produced by resampling. There are two techniques for resampling as shown in [Figure 9.7.1](#), and given as follows-

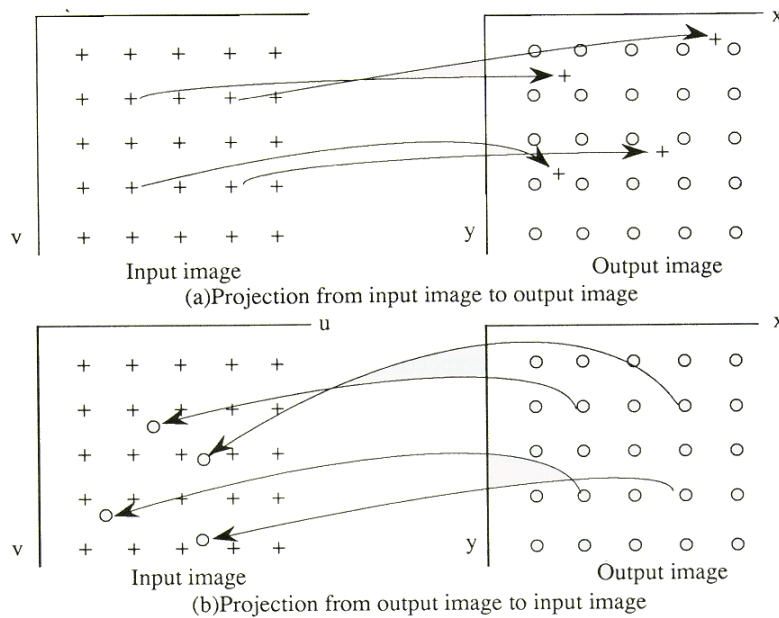

Figure 9.7.1 Resampling Method

(1) Projection from input image to output image

Each pixel of the input image is projected to the output image plane. In this case, an image output device with random access such as flying spot scanner is required.

(2) Projection from output image to input image

Regularly spaced pixels in the output image plane are projected into the input image plane and their values interpolated from the surrounding input image data. This is a more general method.

Usually the inverse equation to transform from the output image coordinate system to the input image coordinate system, is not possible to determine because the geometric equation is very complex. In such a case, the following methods can be adopted-

(1) Partition into small areas

As a small area can be approximated by the lower order polynomials, such as affine or pseudo affine transformation, the inverse equation can be easily determined. Resampling can be undertaken for each small area, one by one.

(2) Line and pixel functions

A line function can be determined approximately to search for a scan line number which is closest to the pixel to be resampled, while a pixel function can be determined to search for the pixel number.

In resampling as shown in [Figure 9.7.1\(b\)](#), a projected point in an input image plane does not coincide with the input image data. Therefore, the spectral data should be interpolated, and the following methods can be used-

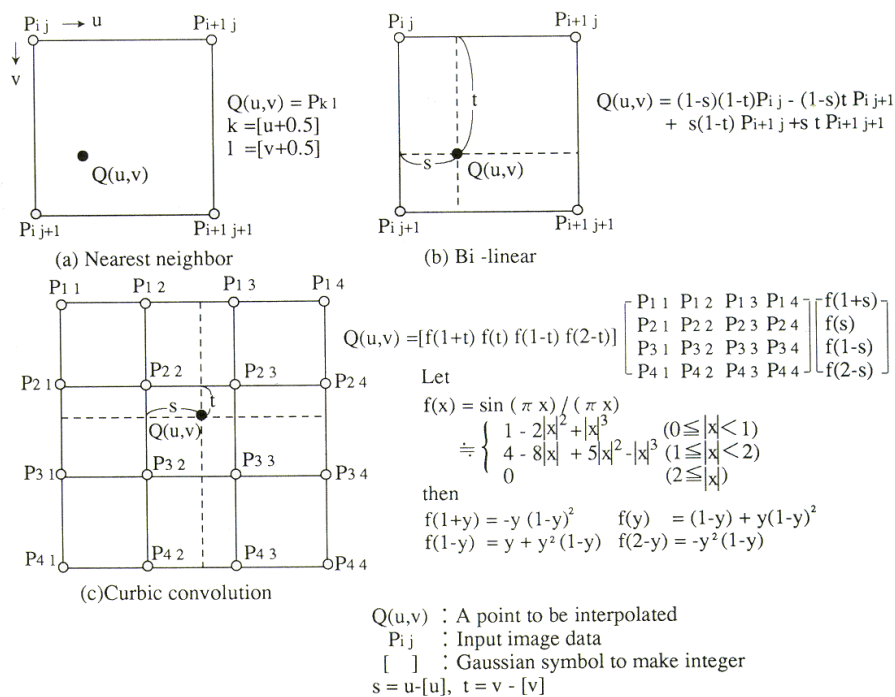

Figure 9.7.2 Interpolation Method

(1) Nearest neighbor (NN)

As shown in [Figure 9.7.2 \(a\)](#), the nearest point will be sampled. The geometric error will be a half pixel at maximum. It has the advantage of being easy and fast.

(2) Bi-linear (BL)

As shown in [Figure 9.7.2 \(b\)](#), the bi-linear function is applied to the surrounding four points. The spectral data will be smoothed after the interpolation.

(3) Cubic convolution (CC)

As shown in [Figure 9.7.2 \(c\)](#), the spectral data will be interpolated by a cubic function using the surrounding sixteen points. The cubic convolution results in sharpening as well as smoothing, though the computation takes a longer time when compared with the other methods.

9.8 Map Projection

A **map projection** is used project the rotated ellipse representing the earth's shape, to a two-dimensional plane. However, there will remain some distortions because the curved surface of the earth cannot be projected precisely on to a plane.

There are three major map projection techniques; perspective projection, conical projection and cylindrical projection, which are used in remote sensing. There are described as follows.

a. Perspective projection

The perspective projection projects the earth from a projection center to a plane as shown in [Figure 9.8.1](#). The **Polar stereo projection** is a perspective projection, as shown in [Figure 9.8.2](#), which projects the northern or southern hemisphere from a projection center at the opposite pole to a vertical plane tangent at the pole. The NOAA Global Vegetation Index (GVI) data are edited in the polar stereo projection.

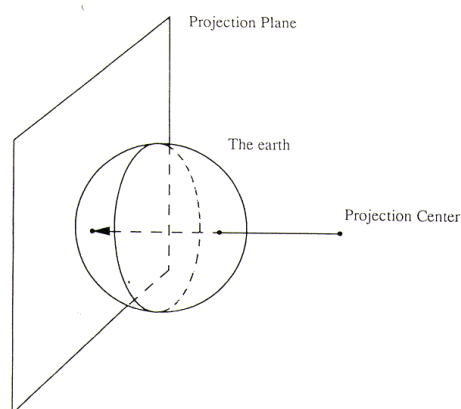

Figure 9.8.1 Perspective projection

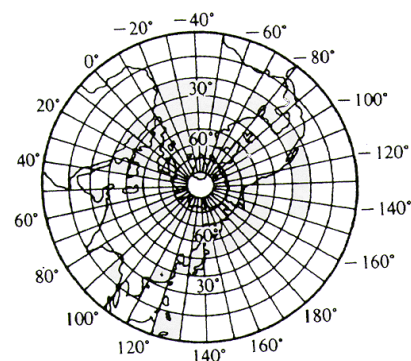

Figure 9.8.2 Polar stereo projection

b. Conical projection

The conical projection projects the earth from the center of the earth to a conical body which envelops the earth. The **Lambertian conical projection** is a typical conical projection with the axis of the conical body identical to the axis of the earth. Aerial navigation charts are drawn using this projection for mid-latitudes, with wider areas from the west to the east.

c. Cylindrical projection

The cylindrical projection projects the earth from the center of the earth to a cylinder which envelops or intersects the earth. The **Mercator projection**, as shown in [Figure 9.8.3](#), is a



Figure 9.8.3 Mercator projection

typical cylindrical projection with the equator tangent to the cylinder. The **Universal Transverse Mercator (UTM)** is also an internationally popular map projection. UTM is a type of **Gauss-Kruger projection**, with the meridian tangent to the cylinder, as shown in [Figure 9.8.4](#). The UTM has an origin point at every six degrees of longitude with a scale factor of 0.9996 at the origin and 1.0000 at a distance of 90 kilometers from the central meridian.

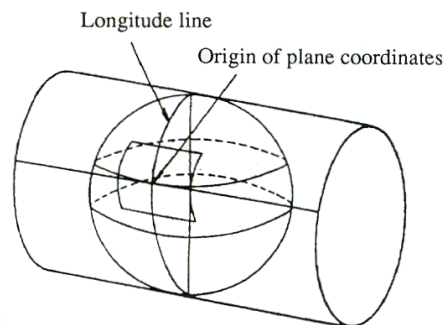

Figure 9.8.4 Gauss-Krueger projection

d. Other projections

For computer processing, a grid coordinate system with equal intervals of latitude and longitude, is often more convenient